



Certificate of CE

MIGUN Thermal massage bed HY-7000E Owner's Manual

More than a massage.

It's beautiful health.

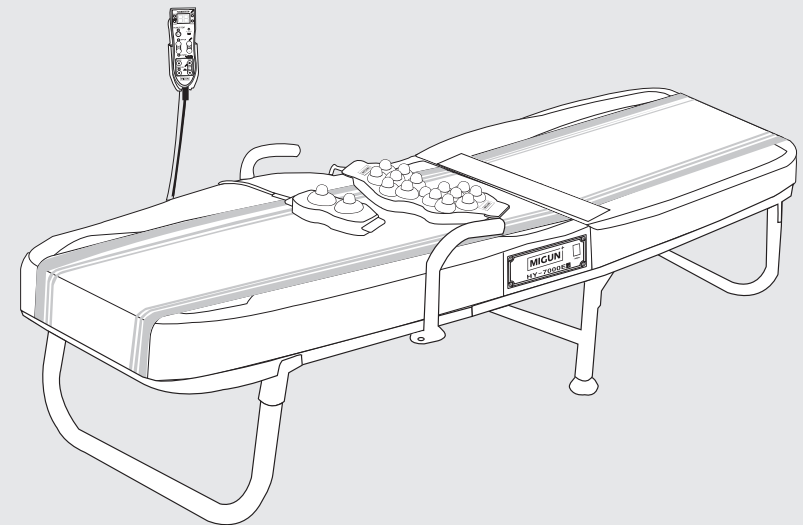

Get Energized!
Get Revitalized!
Get Migunized!

MIGUN⁺

442-42 CHEONGYEON-RO, YEONDONG-MYEON,
SEJONG-SI, 30068 REPUBLIC OF KOREA.
MADE IN KOREA Tel : 82-44-864-1551

MIGUN⁺

Please read this manual carefully so that you can use your MIGUN safely and effectively.
Please keep this manual safe and refer to it whenever you need.

Contents

Important Safeguards	3
Warnings	4
Caution	6
Features and purpose	10
Package Contents	11
Designations and Functional Characteristics-Parts	12
Designations and Functions Characteristics-Control Panel	14
Remote Control	16
Operational Modes	18
How to assemble the frame	20
Specifications	22
Preparing to Use	23
Operational Instruction	25
Proper Storage and Care	39
Error Message/Emergency	40
Troubleshooting	41
Expendable Items	42
Replacing Expendable Items	43
Disposing Used Product/Manufacturer's Label	44
About After Service	46
Warranty Registration Card	47

IMPORTANT SAFEGUARDS

Please read this section carefully before using the product. Please follow these safeguards since they are for are for your safety. This manual uses three degrees of danger, depending on the type of treatments the product gets.



Danger

If this indication is ignored, a severe injury or death may occur.



Warning

If this indication is ignored, an injury or death can occur.



Caution

If this indication is ignored, an injury or property damage can occur.



Warning

Do not disassemble, repair, or modify the product unless you're a certified technician of MIGUN. It may cause a leakage of electricity or dangerous misbehavior of the product.



Caution

Do not disassemble, repair, or modify the product unless you're a certified technician of MIGUN. It may cause a leakage of electricity or dangerous misbehavior of the product.

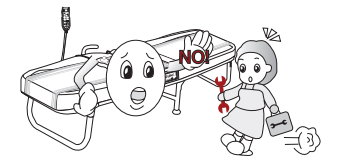





The contents of this manual can be changed without a notice to customers.

These warnings are provided for users to operate our products correctly. Please follow the instructions to avoid an accident or dangerous situation.

- The symbols are to remind a possible danger that a particular condition or operation may cause.
- To avoid a possible danger, please read the following warnings carefully and follow them

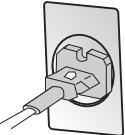
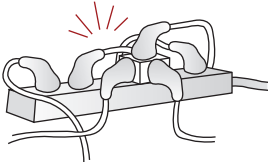
⚠ WARNINGS

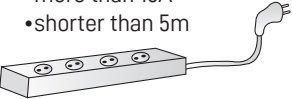
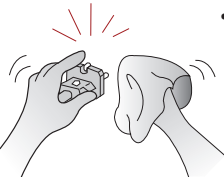

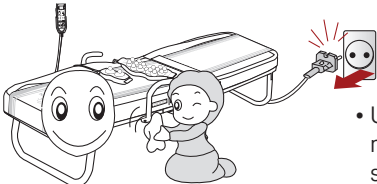
Power Connection and Installation

- Make a secure connection to the outlet. 
- Do not plug the product into a power extension cord with other devices. Fire might be caused from an overheated power extension cord. 
- Do not pull the cord to unplug the power plug. Damage on the cord may cause an electric shock or fire. 
- Do not damage or modify the power cord. Do not over-bend the cord. Do not place a heavy object on the cord. It may cause a leakage of electricity or electric shock. When a power extension cord is needed, the rate of the cord should be as the following. 
- 230V AC
- more than 15A
- shorter than 5m
- 230V AC more than 15A and shorter than 5m
- Keep the power plug clean. A broken or a dirty plug can cause a leakage of electricity or electric shock. 
- Do not plug or unplug the power plug when your hands are wet. Otherwise, an electric shock may occur. 
- Unplug the power plug before cleaning or maintaining the product. Otherwise, an electric shock may occur. 

⚠ WARNINGS

Operation and Location

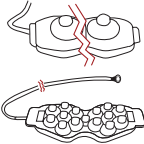
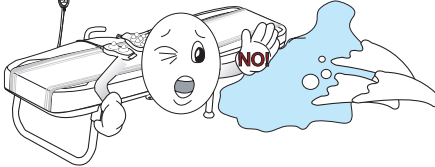
Call for after-sales service 

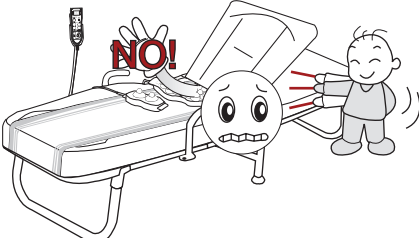
- If a jade massage head or a connection cable is damaged, stop using it immediately and contact the store where you purchased the product or the MIGUN headquarter. A continuous use of damaged accessories may cause an electric shock or fire. 
- Do not expose the product to water or operate the product when it's wet. An electric shock may occur. 
- Do not take a bulb out from jade massage heads. An electric shock may occur. 
- Contact the store where you purchased the product or the MIGUN headquarter if you need to replace a bulb.
- If there is a problem, stop using the product immediately and contact the store where you purchased the product or the MIGUN Headquarter or MIGUN headquarter. 
- The operation will not stop even though the mattress cover is removed during an operation. Do not remove the mattress cover during an operation and keep your hands off from the internal parts. You might get hurt. 

⚠ CAUTION

Caution & Power Connection and Installation



- Do not route the power cord across a walkway.

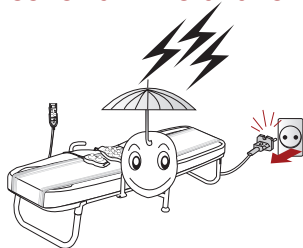

- Unplug the power cord when there is a lightning or thunderstorm.

- This appliance has a hot surface. (Jade massage head) Persons insensitive to heat must be careful when using the appliance.
- This appliance has to be locked by key on the zipper. Because there are electrical, mechanical hazard. When you use it normally, don't open the padlock.

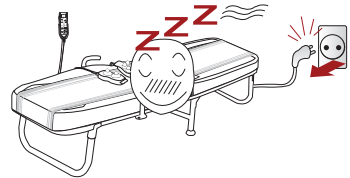

- Unplug the power cord when you don't use the product. That will prevent a leakage of electricity or fire.

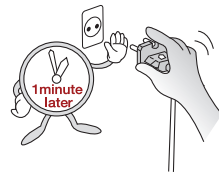

please wait at least a minute

- After unplugging the power cord, please wait at least a minute to plug it back in. Otherwise, the product may malfunction due to the overdrive.

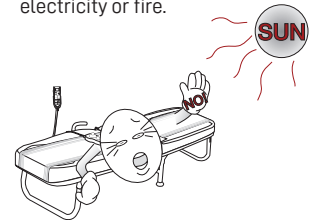

- Do not place the product under direct sunlight. The color of the product may fade.

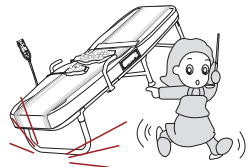

Call for after-sales service

- If the product is dropped or hit during shipping and handling, contact the store where you purchased the product or the MIGUN Headquarter before using it.

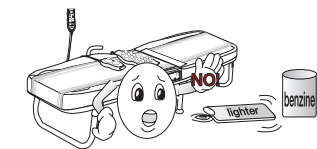

- Do not place flammable materials near the product. Fire may occur.

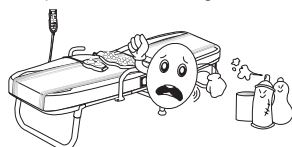

- Corrosive materials such as acid should be stored far from the product. It might corrode the product to cause malfunctioning.

⚠ CAUTION

Operation and Location

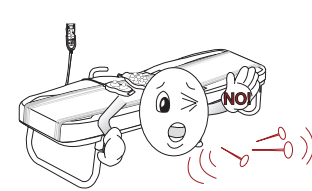

- Do not let a sharp object touch the product.
- It might cause damage or malfunctioning of the product.

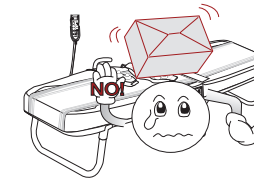

- Do not place anything on the product for storage.
- It might damage the objects on the product.

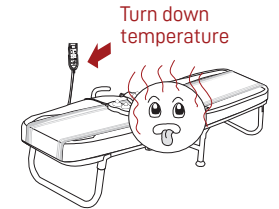

- Turn down temperature when it's too hot. You may get burnt from the excessive heat.

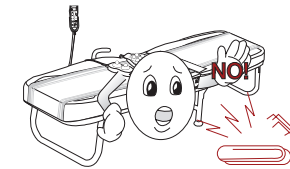

- Do not let small objects such as paper clips or staples get into the product.
- It might cause damage or malfunctioning of the product.

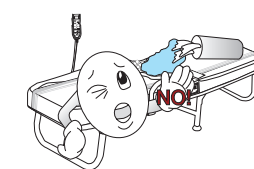

- Do not bring beverage near the product. Spilt beverage can cause malfunctioning or fire by shorting the circuit out.



- Do not apply excessive force to the product during an operation. It might cause damage or malfunctioning of the product.

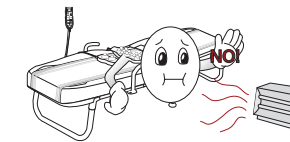

- Do not place the product close to fire or a heating device. It may cause an electric shock or fire.

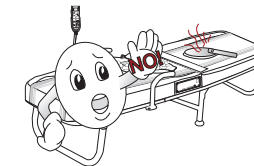

- Do not smoke near the product during an operation. The ashes can get into the product to cause malfunctioning or fire.

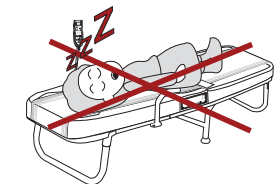

- Be careful not to fall asleep while receiving a treatment. The intensity of a treatment may burn your skin if not monitored carefully.

Please read the operational instruction carefully before using the product.

! CAUTION

Keep children away from the product. The following dangers can occur



• Children can be choked if they wind a cable or a cord around their necks.



• An electric shock or fire can occur if a child bites the power cord or scratches it with a knife.



• Children can drop an external jade massage head and get hurt.

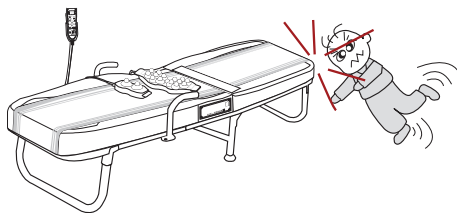

• Children can get hurt from an edge of the product if they fall on it.

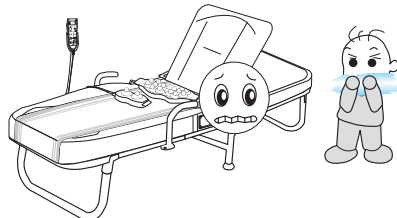

• If a mattress cover is opened, children can rip the sponge off and swallow it to choke themselves.

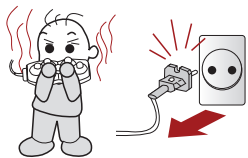

• Turn off the main power when you are not using the product. Children can burn their mouth by putting a heated jade massage head in their mouths.

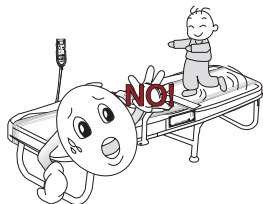

• Do not let children play on the product. They can get hurt, and the product can be damaged.

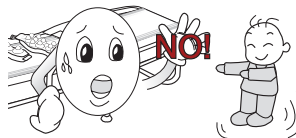

• Keep children away from the product while it's operating.
• Their careless operation can cause fire or an electric shock.

! CAUTION

Before Using The Product.



- Use it as a doctor's guide.
- Consult with a doctor if you have following health conditions:
 - ① acute diseases
 - ② malignant tumors
 - ③ high fever
 - ④ heart problems (especially if using a pace maker).
 - ⑤ perceptual disorder
 - ⑥ pregnant
 - ⑦ skin problems
 - ⑧ artificial organs or skeletons.

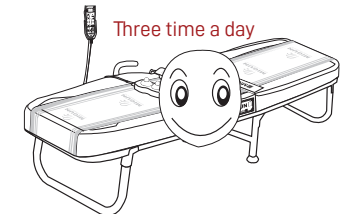

• We recommend using the product less than three times a day.



• If you want to use the product more than once a day, try using it at least 4 hours later.

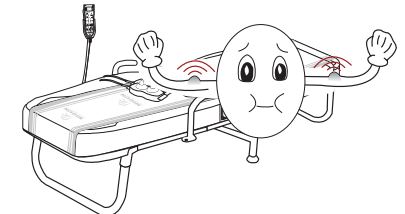

• Do not use the product for purposes other than improving health.

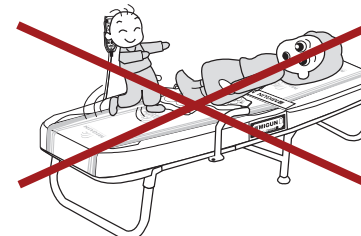

• Do not use the product when you are not properly positioned on the product. A critical damage can occur to the product.

Call for after-sales service

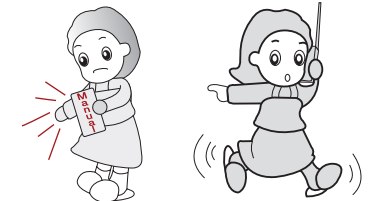

• If you have questions that are not answered by this manual, contact the store where you purchased the product or the MIGUN headquarter before using the product.

MIGUN is doing our best in caring for our customer's safety and health.

Features and purpose

Features

- Please read this manual carefully before using the product, and contact the store where you purchased the product or the MIGUN Headquarter if you have any questions.
- The treatment area of the main body has been extended to cover to the lower hip area.
- The treatment area of the lower body has been designed to cover from the thigh to the ankle, thereby treating the entire body.
- Users can choose from seven operational modes. (Refer to operational modes on pg. 18 ~19)
- The external jade massage heads can be applied on desired areas effectively.
- Depending on the selected operational mode, moving speed of the internal jade massage heads changes between low, middle, and high setting.
- A simple click of the remote control makes the operation easy and quick.

The Purpose

- Migun has dedicated itself to research and develop products that will make a human life healthier and achieve a life span of 100. Migun's purpose for making the product is to improve health, and the product shall not be used for a purpose other than that.

Package Contents

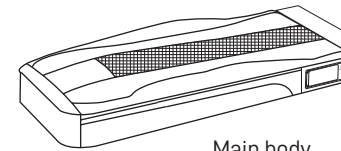

Main body

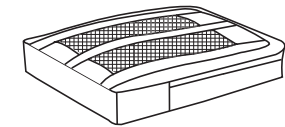

Lower Body

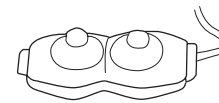

2-Way
Jade Massage Head

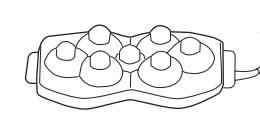

7-Way
Jade Massage Head
(Sold Separately)

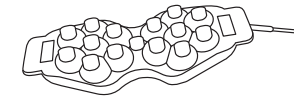

15-Way
Jade Massage Head



Remote
Control

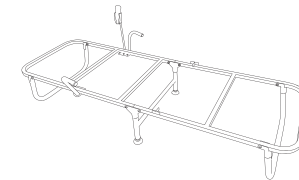

Supporting Frame for
Main and lower bodies
(Metal frames are sold separately)

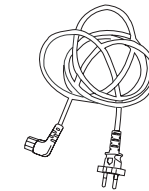

Power Cord

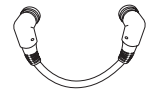

Connecting Cable
for Main and
Lower Bodies



Protective External Layer for Body



Owner's Manual



Product Catalogue

Designations and Functional Characteristics - Parts



1. Remote Control

It controls temperature settings of all jade massage heads and movements of the internal jade massage heads. It can be easily stored in the supporting frame for the remote control.

2. Protective External Layer

It protects the internal jade massage heads. It can be detached for cleaning.

3. Supporting Frame for Main and lower bodies

A birch color would go well with any color of your furniture.

4. External Jade Massage Heads

They provide a thermal treatment to any desired treatment area.

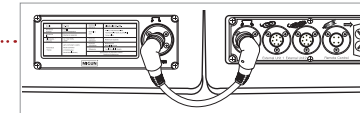
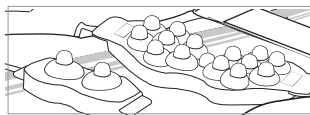

5. Connection Terminals

They are for the connecting cables for the lower body, power supply, external jade massage heads, and remote control.

6. Lower Body

Two internal jade massage heads provide a thermal and massage treatment to your lower body according to the selected operational mode.

7. Main body

Two internal jade massage heads provide a thermal and massage treatment to your upper body according to the selected operational mode.

8. Main Power

It connects to a power outlet.

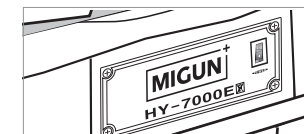

Designations and Functions - Control Panel

Main body Label Panel



Main Power Switch : Turns on or off the product.

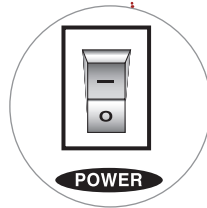

Lower Body Label Panel

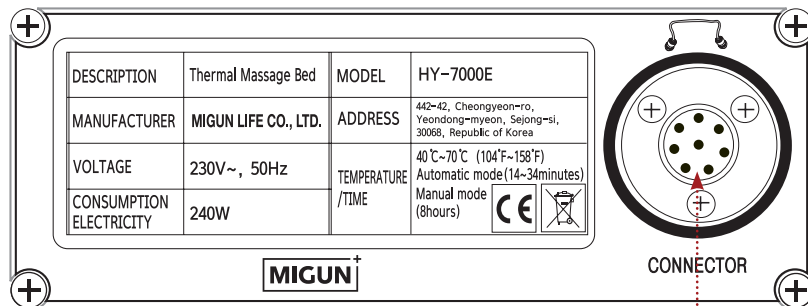

Connection terminal : Connects to the main body.

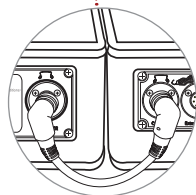

Power Connection Panel

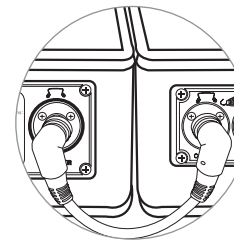
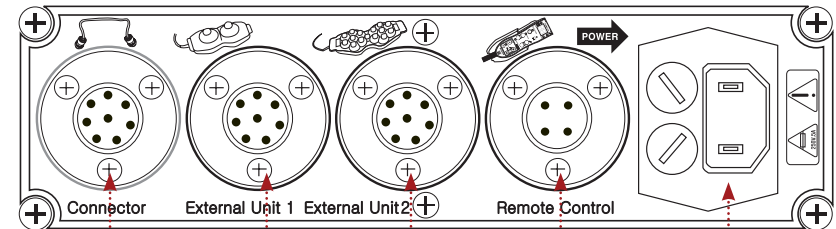

1. Connection Terminal
Connects to the lower body

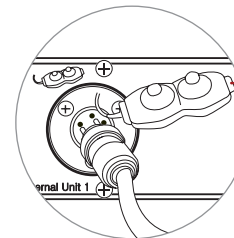

2. External Projector Terminal 1
Connects to a external jade massage head

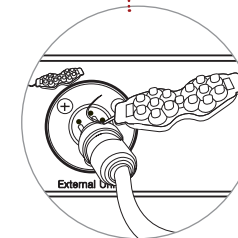

3. External Projector Terminal 2
Connects to a external jade massage head

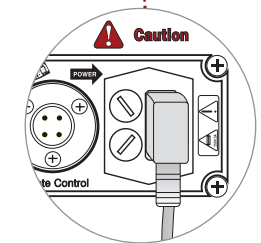

5. Power Terminal

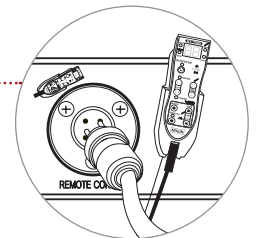

4. Remote Control Terminal
Connects to the remote control

Remote Control

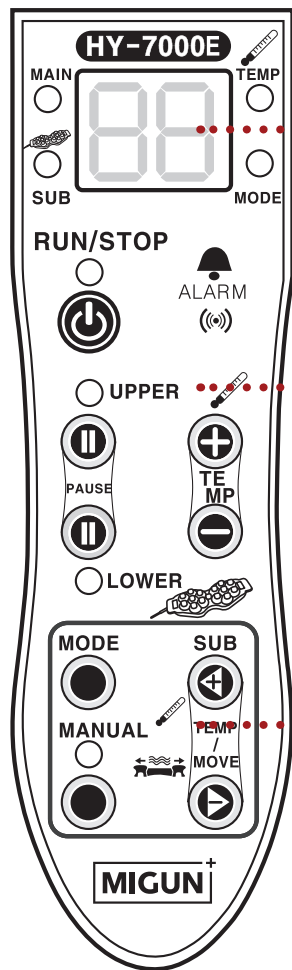

Display Monitor

Indicates temperature and operational status

Jade Massage Head LED

Indicates which jade massage head is in control

Run/Stop Button

Starts and stops the operation of the internal jade massage heads

Pause Buttons

Pauses the movement of the internal jade massage heads

Operational Mode Button

Selects an automatic operational mode (P1~P6) of the internal jade massage heads in the main body (refer to pg 18 'Operational Modes')

Manual Button

Selects a manual operation of the internal jade massage heads in the main body

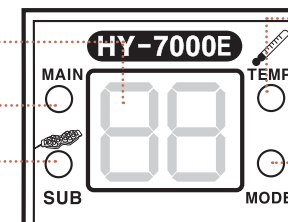

Temperature LED

Indicates that temperature is displayed in the display monitor

Mode LED

Indicates the operational status of the internal jade massage heads

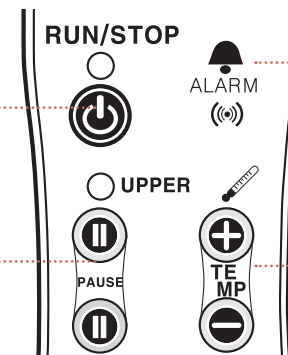

Alarm

Bleeps to indicate an error or a completion of a treatment session.

Internal temperature set buttons

Sets temperature of the internal jade massage heads

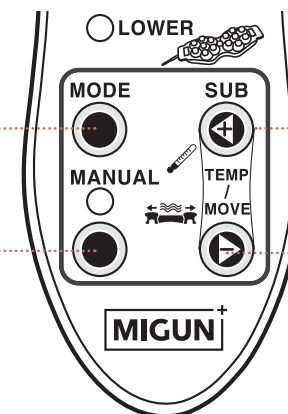

Temperature / Movement Buttons

Sets temperature of the External Jade Massage Heads and moves the internal jade massage heads in the main body in manual mode.

Operational Modes

Please read the following section carefully to use the product safely and effectively.

Operational Modes	
Operational Mode 1(P1) Basic Massage	<p>1. Operation of the Main body (Main Treatment) · This mode is a special operational mode that is uniquely designed from MIGUN's technology. · This mode automatically applies a thermal, massage, and finger-pressure treatment on your entire upper body.</p> <p>2. Operation of the Lower Body (Supplementary Treatment) This mode automatically applies a thermal, massage, and finger-pressure treatment on the entire lower body.</p>
Operational Mode 2(P2) Darsal Massage	<p>1. Operation of the Main body (Main Treatment) This mode automatically applies a thermal, massage, and finger-pressure treatment, concentrating on your neck and dorsal area.</p> <p>2. Operation of the Lower Body (Supplementary Treatment) This mode automatically applies a thermal, massage, and finger-pressure treatment on the lower body area and the sole of the foot. A desired moving area can be programmed.</p>
Operational Mode 3(P3) Lumar Massage	<p>1. Operation of the Main body (Main Treatment) This mode automatically applies a thermal, massage, and finger-pressure treatment, concentrating on your lumber area, which is the center of a human body.</p> <p>2. Operation of the Lower Body (Supplementary Treatment) This mode automatically applies a thermal, massage, and finger-pressure treatment on the entire lower body.</p>
Operational Mode 4(P4) Finger Massage	<p>1. Operation of the Main body (Main Treatment) This mode automatically applies a finger-pressure treatment on your entire upper body. This operation finishes with massage treatments.</p> <p>2. Operation of the Lower Body (Supplementary Treatment) This mode automatically applies a thermal, massage, and finger-pressure treatment on the entire lower body.</p>

Operational Modes	
Operational Mode 5(P5) General Massage	<p>1. Operation of the Main body (Main Treatment) This mode automatically applies a massage treatment on your entire upper body. Speed of the movement changes automatically between Low, Middle, and High setting.</p> <p>2. Operation of the Lower Body (Supplementary Treatment) This mode automatically applies a thermal massage, and finger-pressure treatment on the entire lower body.</p>
Operational Mode 6(P6) Abdomen Massage	<p>1. Abdomen Massage Therapy, Main Body Applies heat, sectional massage, full massage, and acupressure to the abdomen area, while lying face down on the table. If the lower body returns toward the starting point (on the foot), then the lamp on the probes switches off after reaching the set temperature.</p>
Operational Mode 7(P7) Manual Massage	<p>1. Operation of the Main body (Main Treatment) This mode applies a thermal massage, and finger-pressure treatment on the entire or a specific area of your upper body by manually moving the Internal Jade Massage Heads.</p> <p>2. Operation of the Lower Body (Supplementary Treatment) This mode applies a thermal massage, and finger-pressure treatment on the entire or a specific area of your lower body by manually moving the Internal Jade Massage Heads.</p>

※ Note: A treatment takes from 14 minutes to 40 minutes except the Manual Operation (P7), and depending on the weight of a user and input power, there can be an error less than 7%.

System Features

- Uses state-of-the-art micro controller
- Controls movement and temperature accurately
- Sets temperature (increment of 5°C) and indicates it (accuracy of 1°C)
- Operates main body and lower body simultaneously or separately
- Each external jade massage head connecting cable can be connected to any terminal
- Indicates error codes (for an easy service)

Assembling diagram for supporting frame

NOTE : When assembling, pay attention to safety accidents such as hand jamming or collision. After confirming the arrangement, finally tighten it tightly.

Components

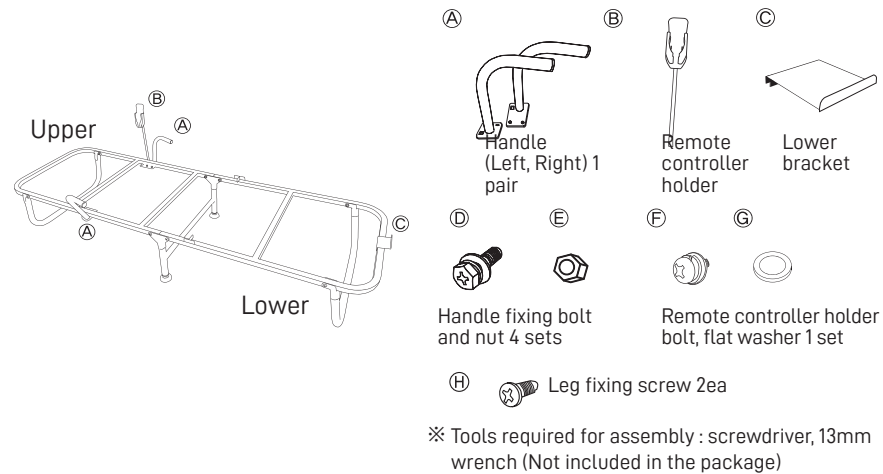

Step 1

- Please take out the frame after opening the box in the normal position.
- Lift the top of the folded frame.
- Extend the (assembled) legs on the top and bottom as shown in Figure 1.

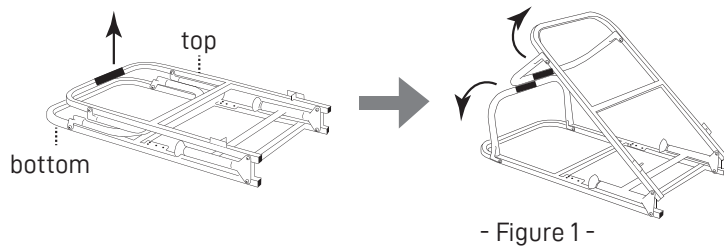

Step 2

- After fixing the center of the lower frame, gently pull the upper frame and place it as shown in Figure 2.
- Extend the folded leg as shown in Figure 2.

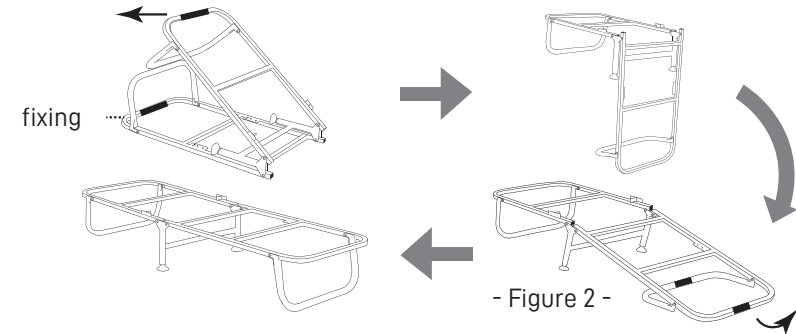

※ Check that the head and leg supports are secured properly. Since the frame is in a temporary assembly state, be sure to tighten the temporarily assembled bolts with a spanner after checking the level.

Step 3

- How to assemble the handle
Insert the handle fixing bolt (D) into the frame from top to bottom.
After inserting the handle from the outside of the frame, assemble in the order of bolt (D) → handle (A) → nut (E)(Figure 3)
- How to assemble the remote controller holder Assemble the remote controller holder fixing bolt (F) → Plate washer (G) → in the direction you want to use (left, right)(Figure 4)

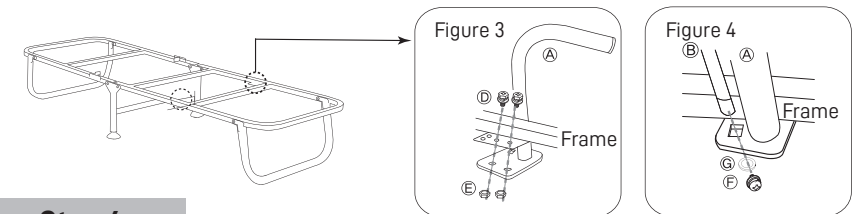

Step 4

- Insert the lower bracket (C) in the center at the bottom of the frame. Finally, tighten the leg fixing screw (H) so that the leg does not move.(Top left inside, bottom right inside 1 each)

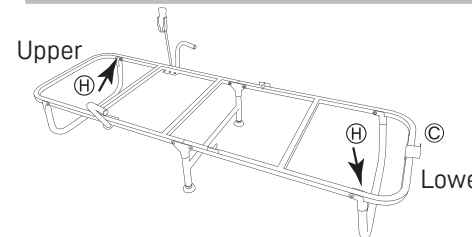

Specifications

Operating Condition	Supply Voltage	AC 220V~AC 240V		
	Power Consumption	240W maximum		
	Frequency	50HZ~60HZ		
	Operating Temperature	40°C~70°C(104°F~158°F)		
External Dimension	Length	Main Body	1,200mm(3.94 ft)	
		Lower Body	800mm(2.62 ft)	
	Width	700mm(2.30 ft)		
Height	120mm(0.39 ft)			
Weight	Main body	32.56kg(71.7 lbs)		
	Lower Body	21.33kg(47.0 lbs)		
	Frame	22.68kg(49.8 lbs)		
	Total	76.57kg(168.5 lbs)		

Preparing to use

NOTE :

1. Install the product on a flat surface. Otherwise, the operation can be noisy or your spine can be positioned badly.
2. Do not install the product in areas with moisture and dirt. It can be harmful to the product.
3. Do not place the product under direct sunlight.
4. Assemble parts with provided orders.

01

Room temperature should be between 50~86°F (10~30°C), and humidity should be between 35~80%.

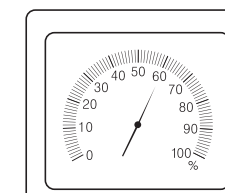
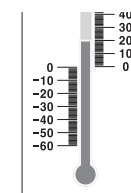

60%

02

- Place the supporting frame for main and lower bodies on a flat and secure surface (refer to pg 20, frame assembly)
- Put the main and lower bodies correctly on the frame.
- Plug the connecting cable for main and lower bodies to the connection terminal and secure the locking cap by turning it clockwise.
- Plug the remote control cable to the remote control terminal and secure the locking cap by turning it clockwise.

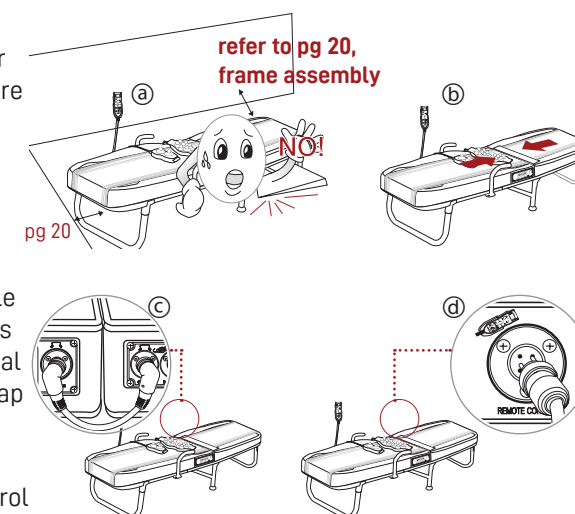

Preparing to use

03

- Plug the connecting cables for the external jade massage head 1 and 2 to the external unit terminal 1 and 2, and secure the locking caps by turning them clockwise

※ Note: any of 2-way, 7-way, and 15-way external jade massage head can be plugged into either external unit terminal 1 or 2.

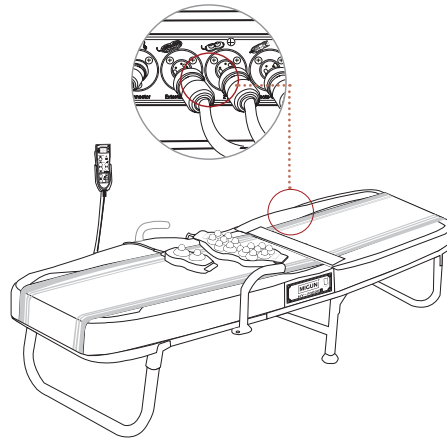

04

- Connect the power cord to the power terminal on the power connection panel.
- Plug the power plug to the outlet.

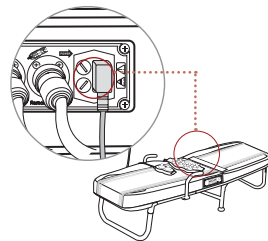

⚠ CAUTION

Do not plug or unplug the power plug when your hands are wet.

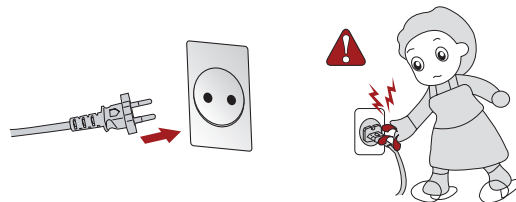

Operational Instruction

⚠ Cautions while operating the product

- Do not set temperature excessively high. It can cause malfunctioning or a skin burn.

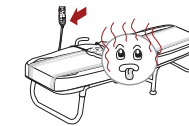

- Do not apply thermal treatment on one spot extensively to avoid getting burnt.

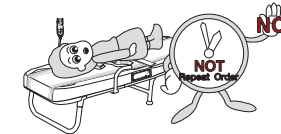

- Start from the lowest temperature setting and gradually increase temperature to avoid getting burnt.

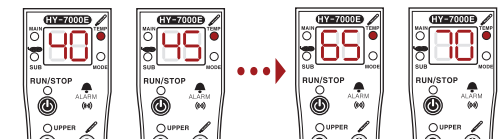

- Apply it on the other spot if you feel uncomfortably hot.

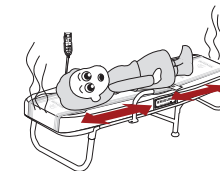

- Keep children away from the product while the product is operating. Their skins are more sensitive to heat.

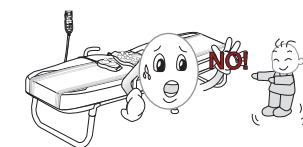

Operational Instruction

- Do not leave the product during a treatment session.

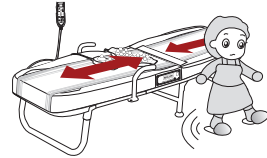

- Do not disassemble, repair, or modify the product on your own. It may cause fire or electric shock.

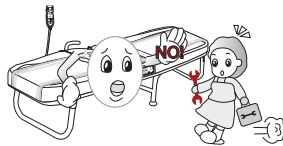

- Be careful not to fall asleep while receiving a treatment. The intensity of a treatment may burn your skin if not monitored carefully.

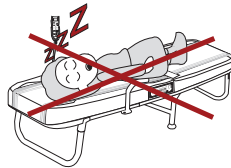

- Do not use the product when you are not properly positioned on the product. A severe damage can occur to the product.



- When the temperature/movement button is pressed when no external jade massage head is connected, an error code of '--' would appear on the display monitor. Check the connections to the external jade massage heads.

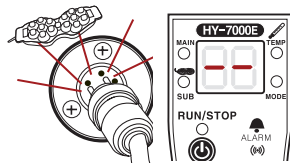

- Connecting and disconnecting the external jade massage heads will not affect the operation of the internal jade massage heads.

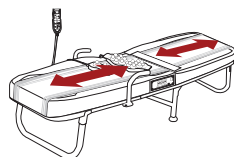

Automatic Operation

In Default Operation

01

Turn on the main power switch, located on the main body label panel. ("00" will appear on the display monitor. If the product is left on for more than 8 hours, it will automatically be turned off for safety purpose.)

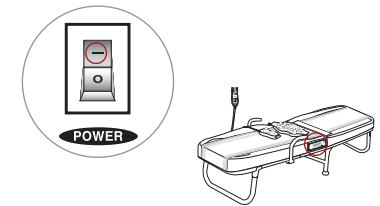

02

Lay down comfortably on the main and lower bodies.

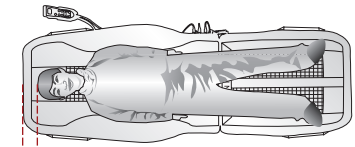

→ Lay down comfortably on the main and lower bodies.

03

- Press the run/stop button on the remote control.
- The run/stop LED will light up green.
- The set temperature of main body will appear on the display monitor. The temperature LED and the internal jade massage head LED, located on each side of the display monitor, will light up green.
- The display monitor will show the selected operational mode and present temperature of the internal jade massage heads by turns.
- Unless you press any button on the remote control for another setting, the product will automatically start with its default settings. When the internal jade massage heads move, the operational mode LED will blink green.

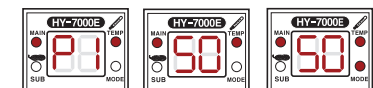
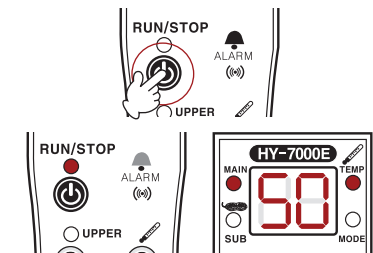

* Main body - automatic, operational mode 1, basic temperature set to 50°C (122°F)

* Lower body - automatic, basic temperature set to 50°C(122°F)

Operational Instruction

04

- a) To pause the movement of the internal jade massage heads in the main body, press the main pause button.
- b) The main pause LED will light up red.
- c) To resume the movement, press the same button again.
- d) The main pause LED will be turned off, and the internal jade massage heads will start moving.

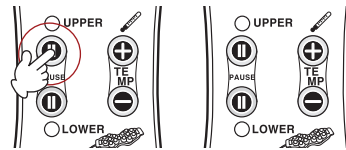
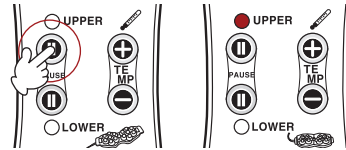

05

- a) To pause the movement of the internal jade massage heads in the lower body, press the lower pause button.
- b) The lower pause LED will light up red.
- c) To resume the movement, press the same button again.
- d) The lower body LED will be turned off, and the internal jade massage heads will start moving.
- e) The product will beep when the selected operational mode is completed.

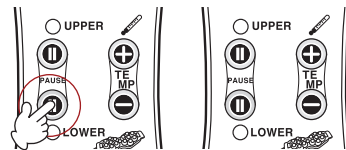
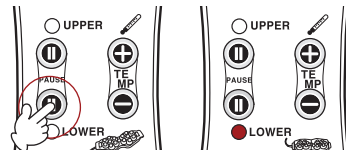

(If either internal jade massage head is remained paused for more than 2 minutes, the internal jade massage heads would be turned off for safety.

To turn on the internal jade massage heads again, just press any internal temperature set button.)

06

- Turn the main power switch off when a treatment session is done.
- If the power is not turned off, the selected operational mode is saved for the next session.
- If the power is turned off, the operational mode 1 (P1) will be saved as a default for the next session.
- When the start/stop button is pressed, a saved operational mode will be started.

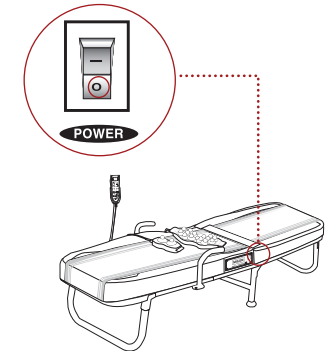

Operational Instruction

To Select Operation Mode (Mode 1~Mode 6) of Main body

01

- Ⓐ Press the run/stop button on the remote control.
- Ⓑ The temperature set for the internal jade massage heads will appear on the display monitor.

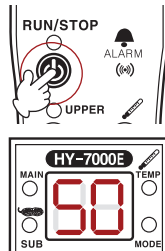

02

- Ⓐ Press the Operational Mode Button once. The mode number from the previous operation would appear on the display monitor. Keep pressing the Operational Mode Button until a desired mode (P1~P6) appears.
- Ⓑ Unless you press any button on the remote control for another setting, the present temperature of the internal jade massage heads appears on the display monitor, and the product will automatically start to operate with the selected operational mode. (If a different operational mode is selected during the operation, it will start the selected operational mode from the beginning. The pause buttons will not work when the internal jade massage heads in the main body are moving to the starting points (head area) to start the newly selected operational mode.)
- Ⓒ If the power is not turned off after a treatment session is done, the selected operational mode is saved for the next session. (If the power is turned off, the operational mode 1 (P1) will be saved as a default for the next session.)
- Ⓓ When the start/stop button is pressed, the saved operational mode will be started.

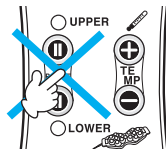
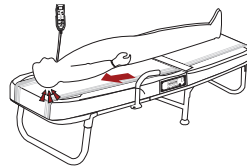
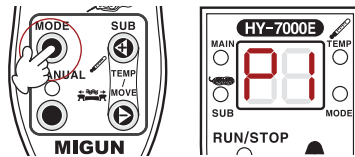

To Set Massage Area for Lower Body for Operation Mode 2(P2)

01

- Ⓐ Press the run/stop button on the remote control.
- Ⓑ The temperature set for the internal jade massage heads will appear on the display monitor.

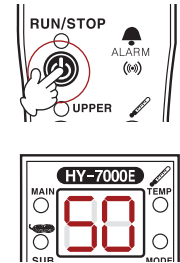

02

- Ⓐ Press the Operational Mode Button once. The mode number from the previous operation would appear on the display monitor. Keep pressing the Operational Mode Button until the operational mode 2 (P2) appears.
 - * In the operational mode 2 (P2), the lower body will massage the entire lower body by default.
- Ⓑ When the jade massage heads lower pause button. The lower pause LED will turn on red.
- Ⓒ After the jade massage heads in the lower body pause for a short time, they will start moving on the set area.

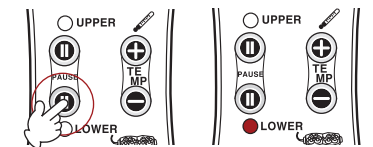
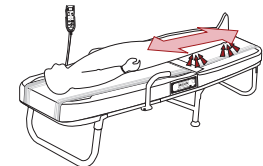
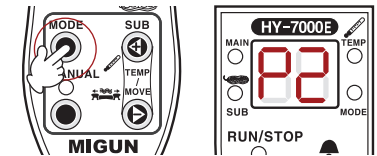

Operational Instruction

To Change Temperature of Internal Jade Massage Heads

01

- Ⓐ Press the run/stop button on the remote control.
- Ⓑ The temperature set for the internal jade massage heads will appear on the display monitor.



02

- Ⓐ Press any internal temperature set button once.
- Ⓑ The temperature set for the internal jade massage heads will appear on the display monitor.

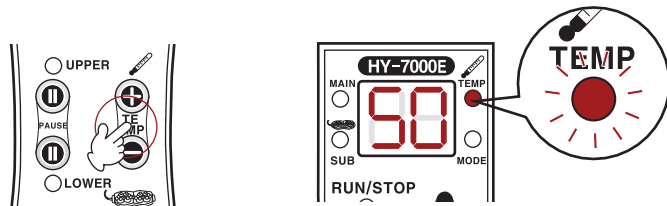
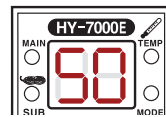

03

Select desired temperature by pressing either 'up' or 'down' button of the internal temperature set buttons.

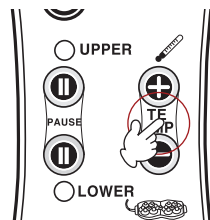

04

- * The range of temperature is between 40~70°C (104~158°F) with an increment of 5°C.
- * Unless you press an internal temperature set button, the display monitor will show the selected operational mode and present temperature of the internal jade massage heads by turns.

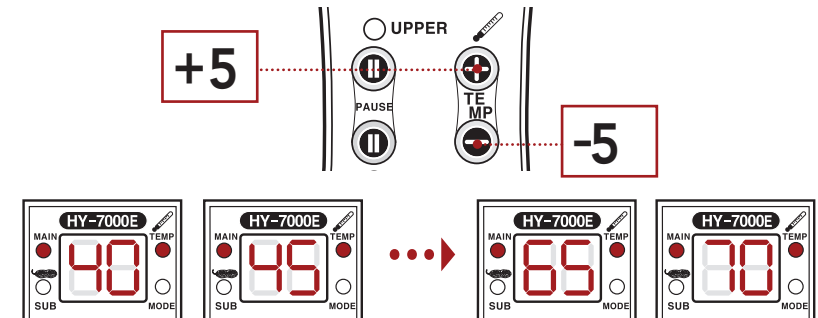

05

The internal temperature set button controls temperature of the main and lower bodies together. Temperature can be changed any time, and it doesn't affect the operation.

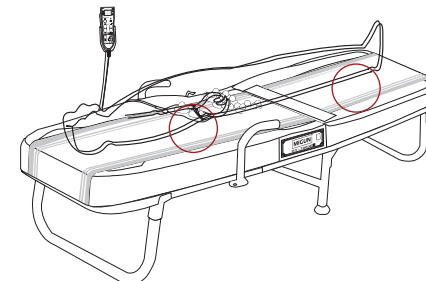

Operational Instruction

Manual Operation

To use Main Body Manually(P7)

01

- Ⓐ Press the run/stop button on the remote control.
- Ⓑ The temperature set for the internal jade massage heads will appear on the display monitor.

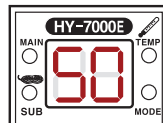
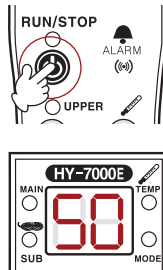

02

- Ⓐ Press the manual button, located on the lower left side of the remote control.
- Ⓑ The manual operation LED will light up green.
- Ⓒ Manual operation (p7) will appear on the display monitor.
- Ⓓ The internal jade massage heads will stop moving.

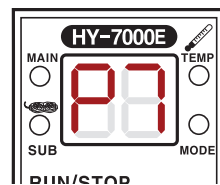
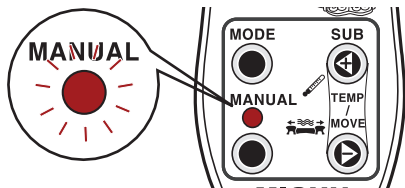
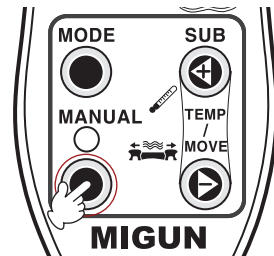

03

- Ⓐ When the temperature/movement down button (located on the lower right side of the remote control) is pressed, the internal jade massage heads in the main body will move to the lower back area.
- Ⓑ When the temperature/movement up button is pressed, the internal jade massage heads in the main body will move to the head area.
- * The lower body will remain in the automatic operational mode selected from the previous operation.
- * In manual mode, temperature of the external jade massage heads will remain same as the temperature set from the previous operation.

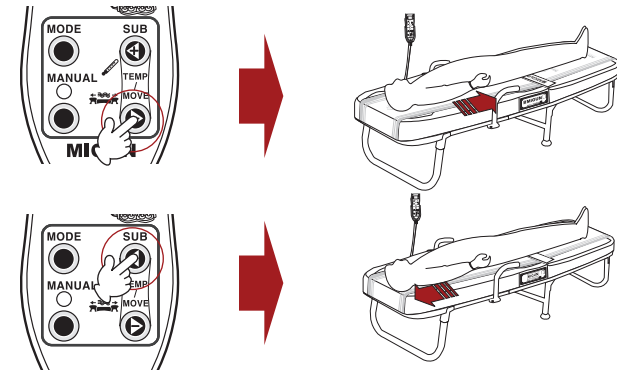

04

- Ⓐ To stop the manual operation, press the manual button again.
- Ⓑ The manual operation LED will be turned off, and the product will start the automatic operation selected from the previous session.



Operational Instruction

To use External Jade Massage Head1 and 2

01

Turn on the main power switch, located on the main body label panel.

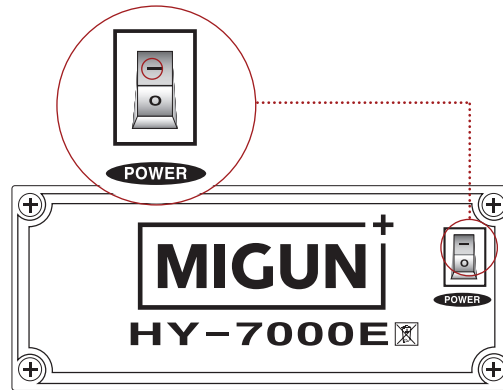

02

Turn on the external jade massage heads. The power switches are located on the side.

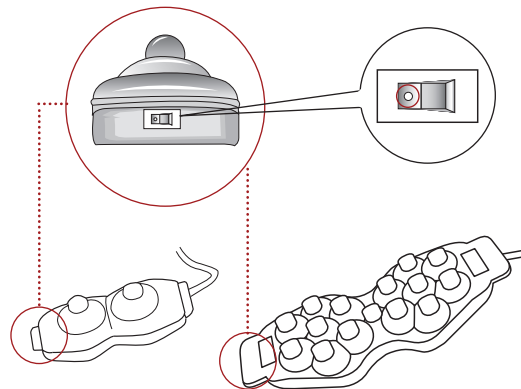

03

- Ⓐ If any temperature/movement button is pressed, the set temperature of the external jade massage heads appears on the display monitor.
- Ⓑ The external jade massage heads LED, located on the lower right side of the remote control, will light up green.

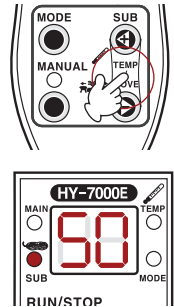

04

Select desired temperature by pressing either 'up' or 'down' button of temperature/movement buttons.

- * The range of temperature is between 40~55°C (104~131°F) with an increment of 5°C(9°F).
- * Unless an internal temperature set button is pressed, the display monitor will alternatively show the selected operational mode and present temperature of the internal jade massage heads.
- * Present temperature of the external jade massage heads will not be displayed.

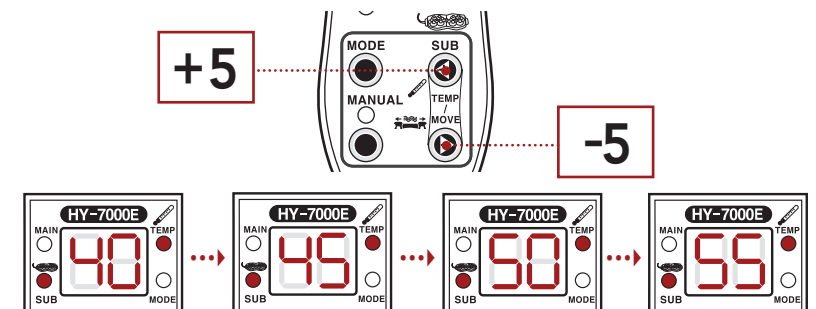

Operational Instruction

05

Apply the external jade massage heads on desired areas of your body.

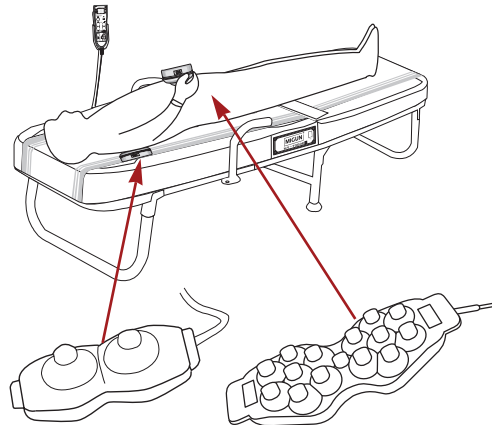

06

When a treatment session is done, turn off the external jade massage heads with the power switches on the side.

* Note: temperature can be changed any time, and it doesn't affect the operation.

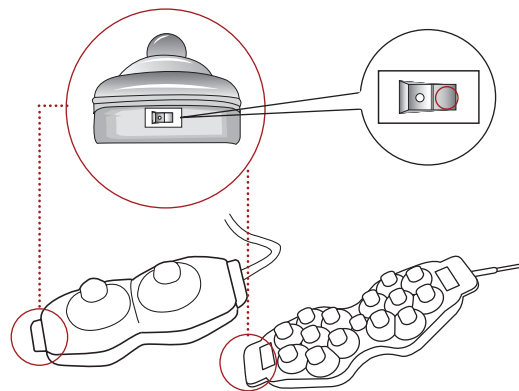

Proper Storage and Care

After Using The Product

1. If an external jade massage head was used, turn off the power switch, located on the side.
2. Turn off the main power switch, located on the right side of the product from user's point of view.
3. Unplug the power plug.

Storage and Care for the Product

1. Store the product in an area that is well-ventilated and is between 50°F~86°F(10~25°C)
2. Do not store or use the product in the environment with high humidity and temperature.
3. Avoid placing the product in direct sunlight.
4. Always place accessories that are not in use in their appropriate storage areas.
5. Keep the product clean.
6. Always disconnect power when cleaning.
7. Do not place the product on any raised surface or platform (more than 1m or 3.28 feet). Dropping the product may cause a malfunction.
 - *Cleaning instructions for extended use:
 - 1) Remove dust from the product on a regular basis.
 - 2) Clean the top of the jade massage heads occasionally. Make sure that the light is always visible when it is in use.

How to Clean the Product

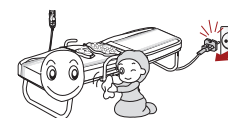

CAUTION

Unplug the power plug before cleaning. An electric shock may occur.

- **Mattress Cover (Synthetic Leather)**
Use a leather cleaner or a dry cloth to clean.
- **Frame**
Use a dry cloth to clean.
- **TC Net**
Remove dust using a vacuum cleaner.
- **Protective External Layer**
Detach for cleaning, and do not apply too much force for cleaning.

Error Message/ Emergency

List of Error Messages

If the following error messages appear on the display monitor, stop using the product and contact the store where you purchased the product or the MIGUN Headquarter.

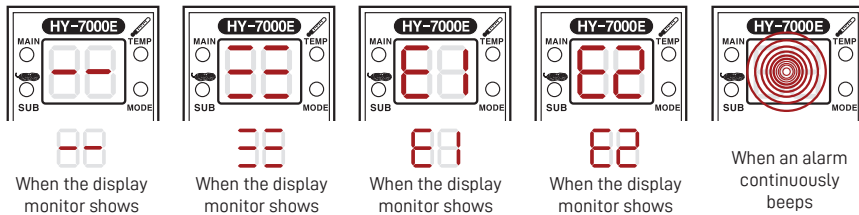

In case of an Emergency

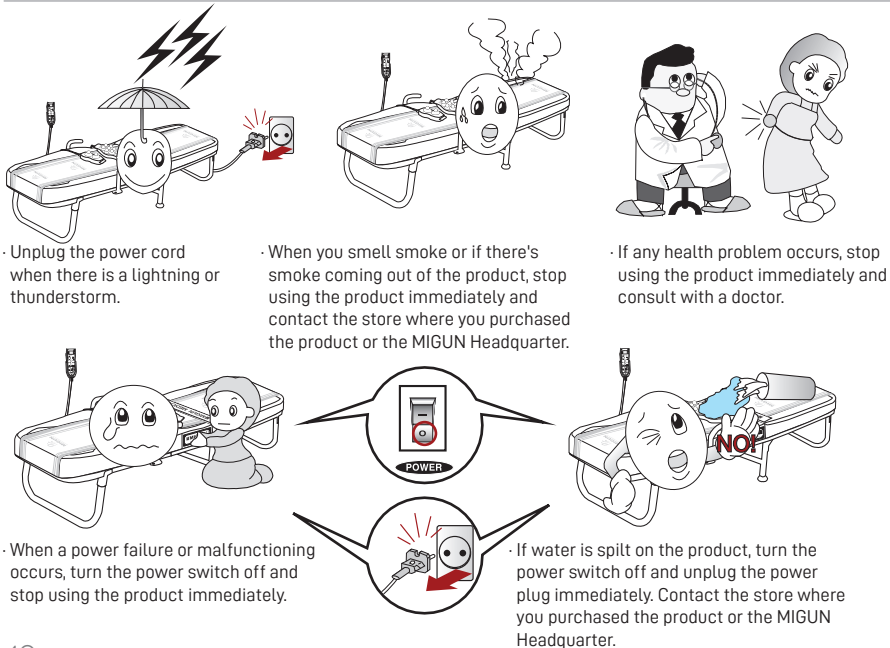

Troubleshooting

When a problem occurs, please check the following lists before contacting MIGUN stores. If you don't read the operational instruction carefully, the product might not operate properly.

Symptom	Check list	Do the following
LED on the remote control doesn't turn on.	Is the remote control cable disconnected?	Plug the cable into the remote control terminal properly.
	Is the main power switch turned off?	Turn the main power switch on.
The internal jade massage heads do not move.	Does the display monitor show '00'?	It is normal before an operation starts. Press the start/stop button.
	Is the 'main' or 'lower' LED below/above the pause buttons on?	The movement is paused. Press a proper pause button once to resume the movement.
	Is the manual operation LED on?	The product is on the manual mode. Press a temperature/movement button to move the internal jade massage heads.
The external jade massage heads do not turn on.	Are the connecting cables for the external jade massage heads disconnected?	Plug the cables into the proper external unit terminals.
	Are the power switches of the external jade massage heads off?	Turn the power switches on.
	Is the main power switch turned off?	Turn the main power switch on.
The temperature setting of the external jade massage heads cannot be controlled.	Is the manual operation LED on?	Set the product to an automatic operation to set temperature of the external jade massage heads.

- ※ It's not malfunctioning even though the internal jade massage heads in the lower body move when the operation is stopped. They are moving to the starting point for the next operation.
- ※ If you still have a problem even after checking all of the above, contact the MIGUN store where you purchased the product.

Expendable Items

Item		peroid	1Month	2Month	3Month	4Month	1 Tear
Tension	Consumers					Replace	
	Demonstration Centers				Replace		
Protective External Layers	Consumers	Wash					Replace
	Demonstration Centers	Wash				Replace	

- ※ For sanitary purpose, the period for washing the protective external layers should be 1/3 in the summer.
- ※ The expendable items used in demonstration centers would wear out faster because of their frequent uses.
- ※ When expendable items are not properly changed or managed according to the schedule, a noise can occur during an operation. Even though it is not malfunctioning, if the items are not properly changed, a severe damage can occur to the product.
- ※ When Tension is placed upside down, the operation might be noisy.

Replacing Expendable Items

Tension

1. Unplug the power plug.
2. Disconnect the connecting cable for the main and lower bodies. (Refer to pg 11)
3. Lift up the main body a little to detach the protective external layers. (Velcro under the product makes it easy to detach.)
4. Open up the mattress cover by unzipping it.
5. Release the rubber band, located on the middle of Tension.
6. Unclip the Tension clipper located at both ends of Tension (the main cover and bearing box for the main body) to replace Tension. Clip the clippers back in.
7. Put the rubber band back to tighten Tension up.
8. Put the mattress cover back on and close the zipper. Attach the protective external layers.
9. Connect the main and lower bodies together using the connecting cable. (Refer to pg 23)

Protective external layer

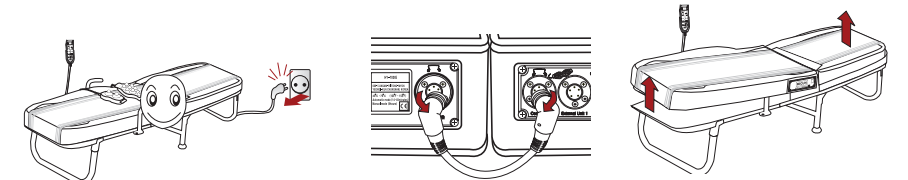

1. Unplug the power plug.
2. Disconnect the connecting cable for the main and lower bodies. (Refer to pg 11)
3. Lift up the main body a little to detach the protective external layers. (Velcro under the product makes it easy to detach.)

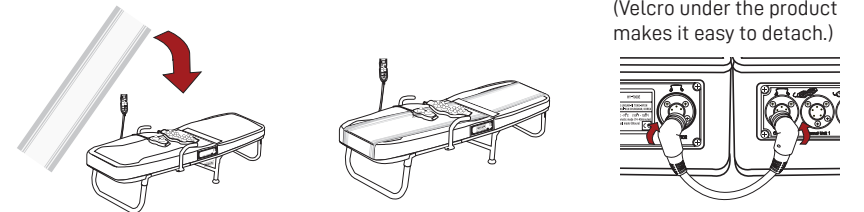

4. After replacing the protective external layer, connect the main and lower bodies together using the connecting cable. (Refer to pg 23)

Expendable Items List

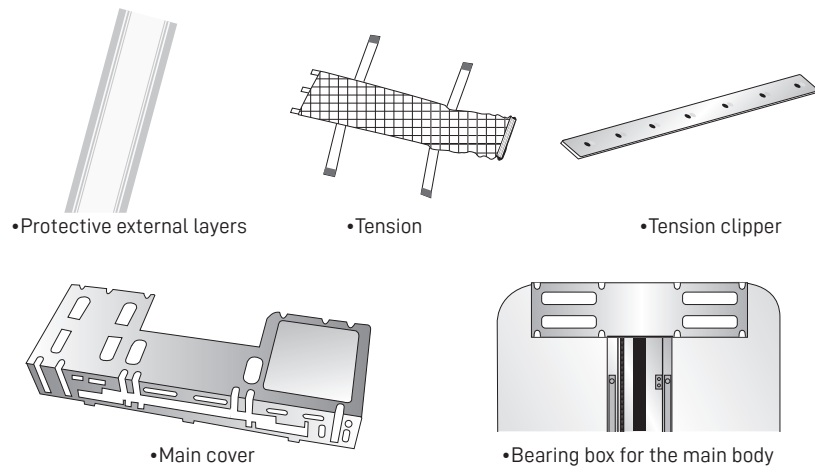

Disposing Used Product / Manufacturer's Label

Disposing a Used Product

When replacing a product with a new one

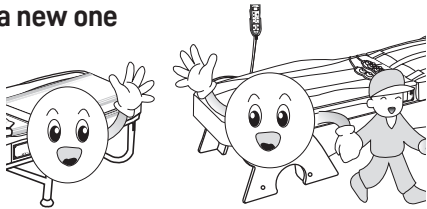

If you replace an old Migun with a new one, Migun will take out the used product for free.

When disposing a used product

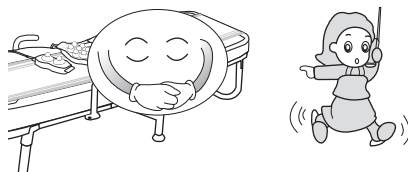

Follow the local garbage disposing process for home appliances.

Manufacturer's Label

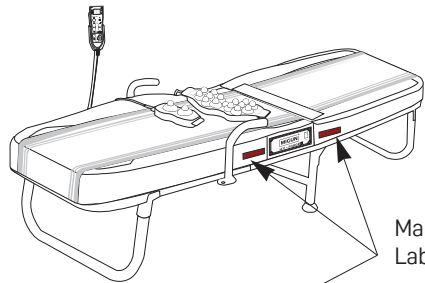

Manufacturer's Label : Apart 1EA

BOX(BOX Side)

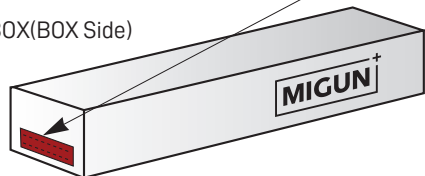

Main and lower bodies are manufactured separately, so the dates of manufacturing can be different.

Disposing a Used Product

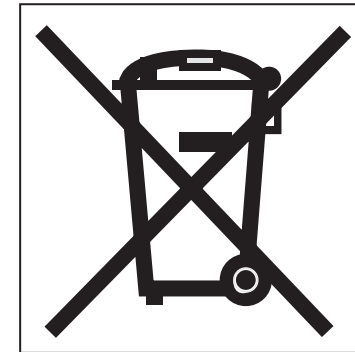

1. When this crossed-out wheeled bin symbol is attached to a product it means the product is covered by the European Directive 2002/968/EC.
2. All electrical and electronic products should be disposed of separately from municipal waste stream via designated collection facilities appointed by the government or the local authorities.
3. The correct disposal of your old appliance will help prevent potential negative consequences for the environment and human health.
4. For more detailed information about disposal of your old appliance, please contact your city office, waste disposal service or the shop where you purchased the product.



Warranty Registration Card

About After-sales Service

- Please read the troubleshooting section carefully before contacting Migun. Migun will help you with questions or problems that are not answered by the troubleshooting section.
- When contacting Migun stores, please let us know the name of the product, the model number, a description of the problem (in detail), your phone number, your address, and your name.

Warranty

- Any defective materials and/ or workmanship of our product is warranted, free of charge, for a period of 12 months from the date of your purchase.
- The warranty is only effective when the information written on the card is true.
- The warranty is effective from the date of your purchase, so please let your sales person write down the date of your purchase on the warranty card.
- This warranty card will not be issued again.

Customer's Rights

You have a right to get a free service for a year if the product has a problem. However, if the problem is caused by a mistreatment or a natural disaster, some service charge would be applicable.

Void of Warranty (Service Charge is Applicable)

- ▷ Warranty is void, even during the period of warranty, if:
 - * problems are caused by owners' carelessness
 - * the product was used under conditions that are not recommended
 - * the owner attempted to repair and/or alter the bed in any way
 - * problems occurred because any foreign object, food, drink, etc. is improperly placed on or in the product
 - * parts from companies other than MIGUN are used
 - * problems are on an expendable part
 - * problems are caused by dropping or hitting the product
 - * problems are caused because the product is plugged into an outlet that is not rated properly
 - * services are provided by someone who is not a certified technician of MIGUN
 - * problems are caused by not following this manual
 - * (You can use the product longer if you follow the safeguards and precautions written in this manual.)

Migun Thermal Massage Bed Warranty

- This warranty is only effective when this card is completed and confirmed at authorized dealer you purchased the product.
- You can contact the store you purchased product or Migun U.S.A. headquarter to get warranty service.
- Do not let anyone repair the product if he/she is not a certified technician by MIGUN Ltd. (due to the use of specially designed circuit board)
- Some service charge might be applicable when the product is malfunctioning due to mistreatment or intentionally applied damage.

Product Name	MIGUN Thermal Massage Bed		Model Name	HY-7000E
Grace Period	1 year from the date of purchase		Product Number	
Purchase Date	Month	Date	Year	Place of Purchase
Customer Information	Name			
	Address			

- To ensure service under warranty, please let your dealer complete this card when you purchase the product.
- Please keep this card safely. You need to show a completed warranty card with the date of purchase when asking for a service.

1. The warranty is only effective as per the information written on the card.
2. The period for warranty starts from the date of your purchase, so please let your sales person complete the information on the warranty card. (If the date of purchase is not written, the warranty period is considered to be started from three months after the date of manufacture.)
3. If the product is used for purposes other than personal use (business use, or use under undesirable conditions), the warranty period would be 6 months.
4. This warranty card will not be issued again.

* possession period of main parts: 5 years * possession period of core parts: 1 year after purchase (6 month at Demonstration Center)

Nature of Damage		Compensation Particulars	
		Within the period of warranty	After the period of warranty
Any damages or technical defects caused during normal operation	A major repair is required within 7 days after purchase	Refund or product exchange	Not Applicable
	A major repair is required within 1 month after purchase	Product Exchange	
	Damaged caused during the process of transportation and installation	Product Refund	10% added to the refund with the penalty ratio
	In case of a product for repair is lost by the dealer		An exchange with a similar parts
	In case of a repair cannot be done because the necessary parts are not provided by the dealer	Repair with similar parts or refund with a penalty ratio	Repairing charge will be applied
Repairable defects	When identical defect occurs 3 consecutive times	There will be no repairing charge	Repairing charge will be applied
	When identical defect occurs 4 consecutive times		Repairing charge will be applied
	When different defect occurs 6 consecutive times	Merchandise exchange / refund with penalty ratio	Repairing charge will be applied
Damage caused intentionally by user or by mistake	Condition of the product is beyond repair	Not Applicable	Not Applicable
	Condition of the product is under repair	Repairing charge will be applied	Repairing charge will be applied
Penalty Ratio	Product Condition		Penalty Ratio
	Return condition is satisfactory		20%
	Resale is impossible due to damage		50%
	The value of the merchandise has been divested due to a serious damage		85%

• This term is based from November 2017, and it can be changed without notice depending on the condition of MIGUN Ltd.